

M5 4.8/5mm ϕ 3-6mm
 #10 (3/16") No.10 1/8" - 1/4"

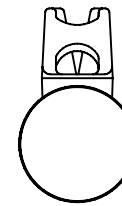
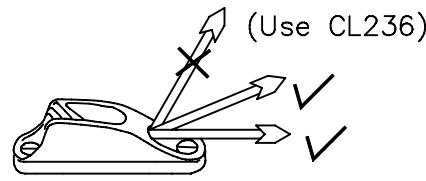

Notes: -
 For marine applications, use a silicone sealant or a bedding compound to avoid electrolytic action between the cleat and metal fastenings.

2 Holes ϕ 5.5
 countersunk ϕ 10.0x90°

Section 'AA'

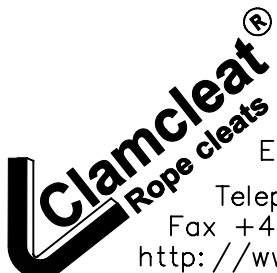
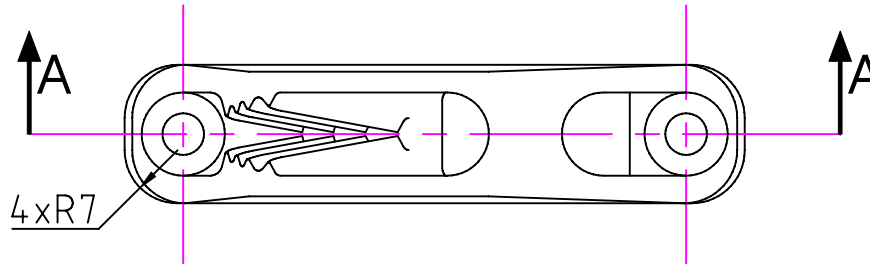
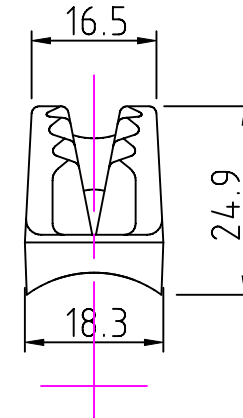
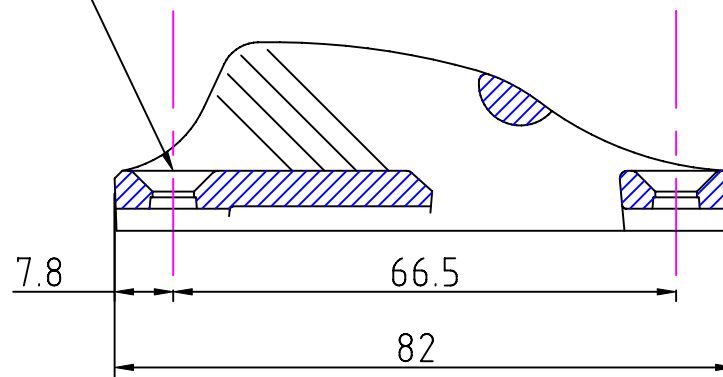
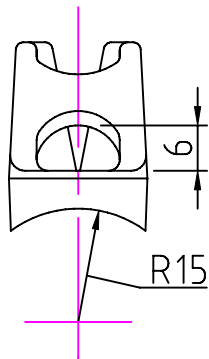

Clamcleats Limited
 Watchmead
 Welwyn Garden City
 Hertfordshire AL7 1AP
 England

Telephone +44 (0)1707 330101
 Fax +44 (0)1707 321269
<http://www.clamcleat-rope-cleats.com>

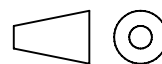

Scale 1:1
 All dimensions in mm.

Issue: 3. May 2006
 ID702.dwg

Material:
 Diecast Aluminium

Installation Drawing for:-

CL702

Aluminium Boom Cleat